



PRISLISTA 2018 CDC ceiling

INNEHÅLL

| | | | |
|------------------------------------|----------|-------------------------------------|--------------|
| AMF Thermatex Akustikskivor | 3 | TOPIQ | 5 |
| Alpha One | | | |
| Alpha | | HERA DESIGN | 6 |
| Thermofon | | | |
| Acoustic RL | | AMF-Ventatec bärkonstruktion | 7 |
| Antaris B | | | |
| Acoustic 38 dB | | | |
| Acoustic 41 dB | | Bärkonstruktion | 8-9 |
| Alpha HD43 dB | | T-43 | |
| Acoustic 43 dB | | Atena gipskonstruktion | |
| Silence 44 dB | | C3 | |
| | | C4 | |
| | | Spegel, guld, mattsvart, silver | |
| Hygien | 4 | Dolt bärsystem | 10 |
| Aquatec | | | |
| Alpha Hygena | | Vägglister | 11-12 |
| Topic Prime Hygena | | | |
| Topiq Efficent Pro Hygena | | Upphängning | 13 |
| Perforerade | 4 | Infästning | 14 |
| Fresko (Fissuredmönster) | | | |
| Star (Pinpointmönster) | | Tillbehör, övrigt | 15 |
| Harmony Kant C (fissuredmönster) | | | |
| Sternbild Kant C (Pinpointmönster) | | Leveransbestämmelser | 16 |

THERMATEX

| Produkt | Kant | Mönster | Format | Tjocklek | Färg | St/m ² | Pris |
|----------------|-------------|---------|---------------------|-----------------------|-------|---------------------|-----------------------|
| Alpha One | A | | 600x600 | 24 mm | Vit | 2,88 m ² | 236 kr/m ² |
| | E15/24 | | 600x1200 | | Vit | 2,88 m ² | 236 kr/m ² |
| | | | 600x600 | | Vit | 2,88 m ² | 276 kr/m ² |
| Alpha | A | Slät | 600x600 | 19 mm | Vit | 3,60 m ² | 166 kr/m ² |
| | A E15/24 | | 600x1200 | | Vit | 5,76 m ² | 166 kr/m ² |
| | | | 600x600 | | Svart | 3,60 m ² | 284 kr/m ² |
| | | | 600x600 | | Vit | 3,60 m ² | 206 kr/m ² |
| | | | 600x1200 | | Vit | 5,76 m ² | 206 kr/m ² |
| | | | 625x625 | | Vit | 3,91 m ² | 206 kr/m ² |
| D | 600x600 | Vit | 3,91 m ² | 354 kr/m ² | | | |
| Thermofon | A | Slät | 600x600 | 15 mm | Vit | 5,04 m ² | 128 kr/m ² |
| | | | 600x1200 | | Vit | 7,20 m ² | 128 kr/m ² |
| Acoustic RL | A | Slät | 600x600 | 19 mm | Vit | 3,60 m ² | 269 kr/m ² |
| Antaris B | A | Slät | 600x600 | 15 mm | Vit | 3,60 m ² | 125 kr/m ² |
| | E15/24 | | 600x1200 | | Vit | 5,76 m ² | 125 kr/m ² |
| | | | 600x600 | | Vit | 3,60 m ² | 168 kr/m ² |
| | | | | | | | |
| Acoustic 38 dB | A | Slät | 600x600 | 19 mm | Vit | 3,60 m ² | 199 kr/m ² |
| | E15/24 | | 600x1200 | | Vit | 5,76 m ² | 199 kr/m ² |
| | | | 600x600 | | Vit | 3,60 m ² | 240 kr/m ² |
| Acoustic 41 dB | | Slät | 600x600 | 24 mm | Vit | 2,88 m ² | 264 kr/m ² |
| | E15/24 | | 600x1200 | | Vit | 4,32 m ² | 264 kr/m ² |
| | | | 600x600 | | Vit | 2,88 m ² | OFFERERAS |
| Alpha HD 43 dB | A | Slät | 600x600 | 35 mm | Vit | 2,16 m ² | 369 kr/m ² |
| | | | 600x1200 | | Vit | 4,32 m ² | 369 kr/m ² |
| Acoustic 43 dB | A | Slät | 600x600 | 30 mm | Vit | 2,16 m ² | 335 kr/m ² |
| | | | 600x1200 | | Vit | 4,32 m ² | 335 kr/m ² |
| Silence 44 dB | A | Slät | 600x600 | 43 mm | Vit | 2,16 m ² | 469 kr/m ² |
| | | | | | | | |

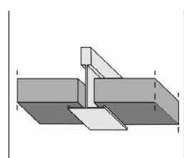

A 15/24

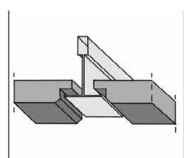

E 15

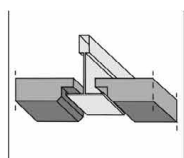

E 24

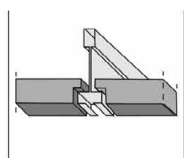

F 15F

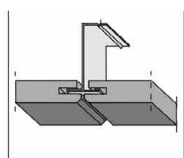

C

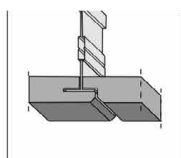

D

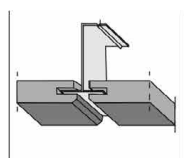

CG-5

THERMATEX / TOPIQ

| Produkt | Kant | Mönster | Format | Tjocklek | Färg | St/m ² | Pris |
|---------------------------|------|----------|--|----------|------|--|--|
| Hygien | | | | | | | |
| Aquatec | A | Slät | 600x600 | 19 mm | Vit | 3,60 m ² | 280 kr/m ² |
| Alpha Hygena | A | Slät | 600x600 | 19 mm | Vit | 3,60 m ² | 209 kr/m ² |
| | | | | | | | |
| | | | | | | | |
| Topic Prime Hygena | A | Slät | 600x600 | 15 mm | Vit | 5,04 m ² | 139 kr/m ² |
| Topiq Efficent Pro Hygena | A | Slät | 600x600 | 20 mm | Vit | 3,60 m ² | 192 kr/m ² |
| Perforerade | | | | | | | |
| | | | | | | | |
| | | | | | | | |
| Fresko | A | Fissured | 600x600 600x1200 625x625 625x1250 | 15 mm | Vit | 5,04 m ² 7,20 m ² 5,47 m ² 7,81 m ² | <u>96 kr/m²</u> <u>96 kr/m²</u> <u>98 kr/m²</u> <u>98 kr/m²</u> |
| Star | A | Pinpoint | 600x600 600x1200 625x625 625x1250 | 15 mm | Vit | 5,04 m ² 7,20 m ² 5,47 m ² 7,81 m ² | <u>96 kr/m²</u> <u>96 kr/m²</u> <u>98 kr/m²</u> <u>98 kr/m²</u> |
| Harmony | C | Fissured | 600x600 625x625 | 15 mm | Vit | 3,60 m ² 3,91 m ² | <u>216 kr/m²</u> 256 kr/m ² |
| Sternbild | C | Pinpoint | 600x600 625x625 | 15 mm | Vit | 3,60 m ² 3,91 m ² | <u>216 kr/m²</u> 256 kr/m ² |

TOPIQ

| Produkt | Kant | Mönster | Format | Tjocklek | Färg | St/m ² | Pris |
|----------------------------|--------|---------|---------------|----------|------|---------------------|-----------------------------|
| Topiq Prime | A | Slät | 600x600 | 15 mm | Vit | 5,04 m ² | <u>110 kr/m²</u> |
| | A | | 600x1200 | 15 mm | Vit | 7,20 m ² | <u>110 kr/m²</u> |
| | E15/24 | | 600x600 | 15 mm | Vit | 5,04 m ² | <u>164 kr/m²</u> |
| Topiq Prime Hygena | A | Slät | 600x600 | 15 mm | Vit | 5,04 m ² | <u>139 kr/m²</u> |
| | A | | 600x1200 | 15 mm | Vit | 7,20 m ² | <u>139 kr/m²</u> |
| Topiq Efficient Pro | A | Slät | 600x600 | 20 mm | Vit | 3,60 m ² | 164 kr/m ² |
| | A | | 600x1200 | 15 mm | Vit | 5,76 m ² | 164 kr/m ² |
| | E15/24 | | 600x600 | 20 mm | Vit | 3,60 m ² | 199 kr/m ² |
| Topiq Efficient Pro Hygena | A | | 600x600 | 20 mm | Vit | 3,60 m ² | <u>192 kr/m²</u> |
| | | | 600x1200 | 20 mm | Vit | 8,64 m ² | <u>192 kr/m²</u> |
| Topiq Sound | A | | 600x600 | 40 mm | Vit | 1,44 m ² | 230 kr/m ² |
| | | | | | Vit | | |
| | | | | | Vit | | |
| | | | | | Vit | | |
| Corridor | A | Slät | 600x1800-2500 | 25 mm | Vit | 12 st | 260 kr/m ² |

HERADESIGN

| Produkt | Stl | Kant | Kulör | Tjocklek | Pris | Tjocklek | Pris | Tjocklek | Pris |
|----------------------|------------|-------------------|-------|----------|-----------------------|----------|-----------------------|----------|-----------------------|
| Heradesign fine | 12X6 | GK rak | vit | 15 mm | 302 kr/m ² | 25 mm | 409 kr/m ² | 35 mm | 494 kr/m ² |
| | 12X6 | SK04 bärverk T-24 | vit | 15 mm | 302 kr/m ² | 25 mm | 409 kr/m ² | 35 mm | 494 kr/m ² |
| | 12X6 | AK01 Fas kant B | vit | 15 mm | 302 kr/m ² | 25 mm | 409 kr/m ² | 35 mm | 494 kr/m ² |
| Heradesign fine | 6x6 | GK rak | vit | 15 mm | 302 kr/m ² | 25 mm | 409 kr/m ² | 35 mm | 494 kr/m ² |
| | 6x6 | SK04 bärverk T-24 | vit | 15 mm | 302 kr/m ² | 25 mm | 409 kr/m ² | 35 mm | 494 kr/m ² |
| | 6x6 | AK01 Fas kant B | vit | 15 mm | 302 kr/m ² | 25 mm | 409 kr/m ² | 35 mm | 494 kr/m ² |
| Heradesign fine | 12X6 | GK rak | natur | 15 mm | 302 kr/m ² | 25 mm | 409 kr/m ² | 35 mm | 494 kr/m ² |
| | 12X6 | SK04 bärverk T-24 | natur | 15 mm | 302 kr/m ² | 25 mm | 409 kr/m ² | 35 mm | 494 kr/m ² |
| | 12X6 | AK01 Fas kant B | natur | 15 mm | 302 kr/m ² | 25 mm | 409 kr/m ² | 35 mm | 494 kr/m ² |
| Heradesign fine | 6x6 | GK rak | natur | 15 mm | 302 kr/m ² | 25 mm | 409 kr/m ² | 35 mm | 494 kr/m ² |
| | 6x6 | SK04 bärverk T-24 | natur | 15 mm | 302 kr/m ² | 25 mm | 409 kr/m ² | 35 mm | 494 kr/m ² |
| | 6x6 | AK01 Fas kant B | natur | 15 mm | 302 kr/m ² | 25 mm | 409 kr/m ² | 35 mm | 494 kr/m ² |
| Heradesign fine | 12X6 | GK rak | svart | 15 mm | 470 kr/m ² | 25 mm | 576 kr/m ² | 35 mm | 662 kr/m ² |
| | 12X6 | SK04 bärverk T-24 | svart | 15 mm | 470 kr/m ² | 25 mm | 576 kr/m ² | 35 mm | 662 kr/m ² |
| | 12X6 | AK01 Fas kant B | svart | 15 mm | 470 kr/m ² | 25 mm | 576 kr/m ² | 35 mm | 662 kr/m ² |
| Heradesign fine | 6x6 | GK rak | svart | 15 mm | 470 kr/m ² | 25 mm | 576 kr/m ² | 35 mm | 662 kr/m ² |
| | 6x6 | SK04 bärverk T-24 | svart | 15 mm | 470 kr/m ² | 25 mm | 576 kr/m ² | 35 mm | 662 kr/m ² |
| | 6x6 | AK01 Fas kant B | svart | 15 mm | 470 kr/m ² | 25 mm | 576 kr/m ² | 35 mm | 662 kr/m ² |
| Heradesign superfine | 12X6 | GK rak | vit | 15 mm | 336 kr/m ² | 25 mm | 442 kr/m ² | 35 mm | 543 kr/m ² |
| | 12X6 | SK04 bärverk T-24 | vit | 15 mm | 336 kr/m ² | 25 mm | 442 kr/m ² | 35 mm | 543 kr/m ² |
| | 12X6 | AK01 Fas kant B | vit | 15 mm | 336 kr/m ² | 25 mm | 442 kr/m ² | 35 mm | 543 kr/m ² |
| Heradesign superfine | 6x6 | GK rak | vit | 15 mm | 336 kr/m ² | 25 mm | 442 kr/m ² | 35 mm | 543 kr/m ² |
| | 6x6 | SK04 bärverk T-24 | vit | 15 mm | 336 kr/m ² | 25 mm | 442 kr/m ² | 35 mm | 543 kr/m ² |
| | 6x6 | AK01 Fas kant B | vit | 15 mm | 336 kr/m ² | 25 mm | 442 kr/m ² | 35 mm | 543 kr/m ² |
| Heradesign superfine | 12X6 | GK rak | natur | 15 mm | 336 kr/m ² | 25 mm | 442 kr/m ² | 35 mm | 543 kr/m ² |
| | 12X6 | SK04 bärverk T-24 | natur | 15 mm | 336 kr/m ² | 25 mm | 442 kr/m ² | 35 mm | 543 kr/m ² |
| | 12X6 | AK01 Fas kant B | natur | 15 mm | 336 kr/m ² | 25 mm | 442 kr/m ² | 35 mm | 543 kr/m ² |
| Heradesign superfine | 6x6 | GK rak | natur | 15 mm | 336 kr/m ² | 25 mm | 442 kr/m ² | 35 mm | 543 kr/m ² |
| | 6x6 | SK04 bärverk T-24 | natur | 15 mm | 336 kr/m ² | 25 mm | 442 kr/m ² | 35 mm | 543 kr/m ² |
| | 6x6 | AK01 Fas kant B | natur | 15 mm | 336 kr/m ² | 25 mm | 442 kr/m ² | 35 mm | 543 kr/m ² |
| Heradesign superfine | 12X6 | GK rak | svart | 15 mm | 503 kr/m ² | 25 mm | 610 kr/m ² | 35 mm | 710 kr/m ² |
| | 12X6 | SK04 bärverk T-24 | svart | 15 mm | 403 kr/m ² | 25 mm | 610 kr/m ² | 35 mm | 710 kr/m ² |
| | 12X6 | AK01 Fas kant B | svart | 15 mm | 503 kr/m ² | 25 mm | 610 kr/m ² | 35 mm | 710 kr/m ² |
| Heradesign superfine | 6x6 | GK rak | svart | 15 mm | 503 kr/m ² | 25 mm | 610 kr/m ² | 35 mm | 710 kr/m ² |
| | 6x6 | SK04 bärverk T-24 | svart | 15 mm | 503 kr/m ² | 25 mm | 610 kr/m ² | 35 mm | 710 kr/m ² |
| | 6x6 | AK01 Fas kant B | svart | 15 mm | 503 kr/m ² | 25 mm | 610 kr/m ² | 35 mm | 710 kr/m ² |
| Skruv 35 x4,5 | 200 st/krt | | galv | | | | | | 199 kr/krt |
| Skruv 50 x4,5 | 200 st/krt | | galv | | | | | | 254 kr/krt |
| Skruv 60 x 4,5 | 200 st/krt | | galv | | | | | | 299 kr/krt |
| Skruv 35 x4,5 | 200 st/krt | | vit | | | | | | 364 kr/krt |
| Skruv 50 x4,5 | 200 st/krt | | vit | | | | | | 406 kr/krt |
| Skruv 60 x 4,5 | 200 st/krt | | vit | | | | | | 446 kr/krt |

Undersruken är normal lagerstandard | Specialkulörer offereras på begäran

AMF-VENTATEC BÄRKONSTRUKTION

| Produkt | Färg | Längd | Antal/kart | m/kart | Vikt | Pris |
|---|------|---------|------------|--------|-------|-------------------|
| T-24 Bärprofil T-24 Brandstansad Tvärprofil T-24 | Vit | 3600 mm | 14 st | 50,4 m | 17 kg | <u>12,80 kr/m</u> |
| | Vit | 1200 mm | 40 st | 48 m | 16 kg | <u>12,80 kr/m</u> |
| | Vit | 600 mm | 40 st | 24 m | 7 kg | <u>12,80 kr/m</u> |
| | Vit | 1800 mm | 40 st | 72 m | 16 kg | <u>18,40 kr/m</u> |
| L-list 24x24 mm | Vit | 3000 mm | 40 st | 120 m | 20 kg | <u>10,60 kr/m</u> |
| L-list 19x24 mm | Vit | 3000 mm | 40 st | 12 0m | 20 kg | 10,60 kr/m |
| T-35 Bärprofil T-35 Brandstansad Tvärprofil T-35 | Vit | 3700 mm | | | | OFFERERAS |
| | Vit | 1200 mm | | | | OFFERERAS |
| | Vit | 600 mm | | | | OFFERERAS |
| T-15 Bärprofil T-15 Tvärprofil T-15 Tvärprofil T-15 | Vit | 3700 mm | | | | OFFERERAS |
| | Vit | 1200 mm | | | | OFFERERAS |
| | Vit | 600 mm | | | | OFFERERAS |



BÄRKONSTRUKTION

| Produkt | Färg | Längd | Antal/kart | m/kart | Vikt | Pris |
|--|--------|---|----------------------------------|-------------------------------|----------------------------------|--|
| C3 T-24 Bärprofil Tvärprofil Tvärprofil L-list 21x21 mm | Vit | 3700 mm 1200 mm 600 mm 3000 mm | 20 st 60 st 60 st 25 st | 74 m 72 m 36 m 75 m | 20 kg 20 kg 10 kg 14 kg | 31 kr/m 31 kr/m 31 kr/m 34 kr/m |
| Armstrong C4 Prelude Prelude Tvärprofil Tvärprofil L-list 24x19 mm | Vit | 3600 mm 1200 mm 600 mm 3000 mm | 20 st 60 st 60 st 36 st | 72 m 72 m 36 m 108 m | 20 kg 20 kg 10 kg | 54 kr/m 54 kr/m 54 kr/m 46 kr/m |
| SPEGEL T-24 Bärprofil Tvärprofil Tvärprofil L-list 32x19 mm | SPEGEL | 3600 mm 1200 mm 600 mm 3000 mm | 20 st 60 st 60 st 30 st | 72 m 72 m 36 m 90 m | 20 kg 20 kg 10 kg 18 kg | 35 kr/m 35 kr/m 35 kr/m 56 kr/m |
| GULD T-24 Bärprofil Tvärprofil Tvärprofil L-list 32x19 mm | GULD | 3600 mm 1200 mm 600 mm 3000 mm | 20 st 60 st 60 st 30 st | 72 m 72 m 36 m 90 m | 20 kg 20 kg 10 kg 18 kg | 42 kr/m 42 kr/m 42 kr/m 44 kr/m |
| SVART T-24 Bärprofil Tvärprofil Tvärprofil L-list 21x21 mm | SVART | 3700 mm 1200 mm 600 mm 3000 mm | 20 st 60 st 60 st 25 st | 74 m 72 m 36 m 75 m | 20 kg 20 kg 10 kg 14 kg | 26 kr/m 26 kr/m 26 kr/m 22 kr/m |
| SILVER T-24 Bärprofil Tvärprofil Tvärprofil L-list 21x21 mm | SILVER | 3700 mm 1200 mm 600 mm 3000 mm | 20 st 60 st 60 st 25 st | 74 m 72 m 36 m 75 m | 20 kg 20 kg 10 kg 14 kg | 26 kr/m 26 kr/m 26 kr/m 22 kr/m |

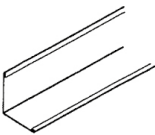
BÄRKONSTRUKTION

| Produkt | Färg | Längd | Antal/kart | m/kart | Vikt | Pris |
|---|------|---------|------------|--------|-------|-------------------|
| T-43 | | | | | | |
| Bärprofil T-43 | Vit | 3700 mm | 12 st | 44,4 m | 19 kg | 35,50 kr/m |
| (för skruvning av gips) | Galv | 3700 mm | 12 st | 44,4 m | 19 kg | <u>35,20 kr/m</u> |
| Tvärprofil T-43 | Vit | 1200 mm | 28 st | 33,6 m | 15 kg | 35,50 kr/m |
| (för skruvning av gips) | Galv | 1200 mm | 28 st | 33,6 m | 15 kg | <u>35,20 kr/m</u> |
| | Galv | 900 mm | 42 st | 37,8 m | 17 kg | <u>35,20 kr/m</u> |
| (för skruvning av gips) | Vit | 600 mm | 42 st | 25,2 m | 11 kg | 35,50 kr/m |
| | Galv | 600 mm | 42 st | 25,2 m | 11 kg | <u>35,20 kr/m</u> |
| L-list 35x35 mm | Galv | 3000 mm | 20 st | 60 m | 15 kg | 48,00 kr/m |
|  | | | | | | |
| | | | | | | |
| | | | | | | |
| ATENA GIPSKONSTRUKTION | | | | | | |
| Duplex Bärskena | Galv | 4000 mm | 10 st | 40 m | | 21 kr/m |
| Skarv Duplex | Galv | | 1000 st | | | 10,40 kr/m |
| C- profil 27x49x27 mm | Galv | 4000 mm | 10 st | 40 m | | 13,40 kr/m |
| Skarv C-profil | Galv | | 100 st | | | 7,30 kr/m |
| Vägglist U 28x30x28 mm | Galv | 3000 mm | 10 st | 30 m | | 10 kr/m |
| Vägglist L 35x35 mm | Galv | 300 mm | 20 st | 60 m | | 14 kr/m |
| Undersruken är normal lagerstandard | | | | | | |

TILLBEHÖR

| Produkt | Färg | Längd | Antal/kart | m/kart | Pris |
|--|-------|-------|---------------|--------|-----------------------------|
| | | | | | |
| Fästbleck  | Galv | | 500 st | | 4,20 kr/st |
| Stvrfiäder  | Plast | | 500 st | | 3,90 kr/st |
| Akustikcement  | | | 12 kg 4 kg | | 1397 kr/burk 853 kr/burk |

Dolt system - Direktmontage

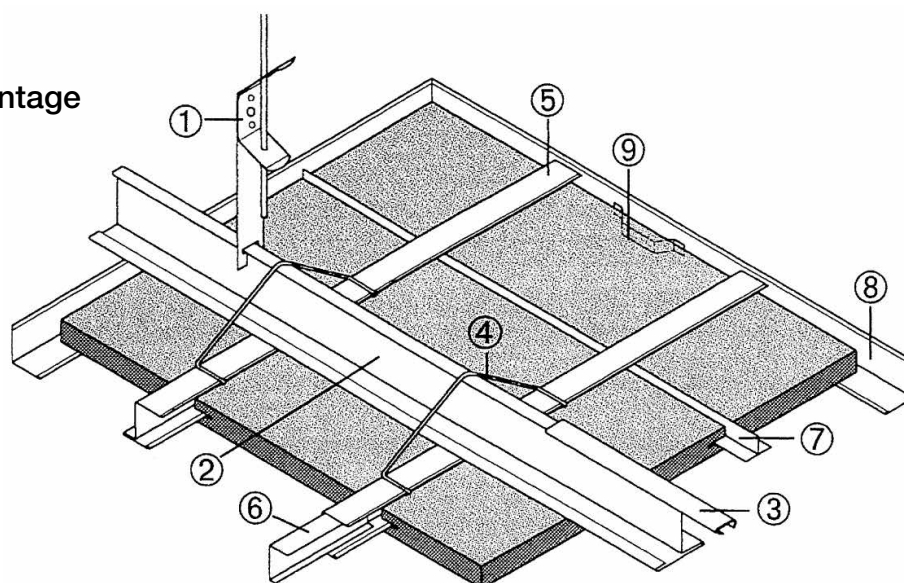

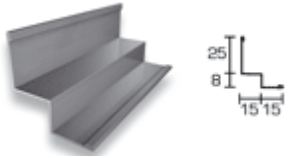
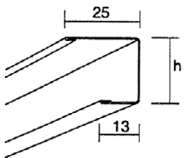
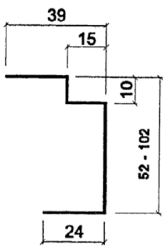

VÄGGLISTER

| Produkt | Färg | Längd | Antal/kart | m/kart | Vikt | Pris |
|--|-------------------|-------------------------------|-------------------------|----------------------------|-------------------------|---|
| | | | | | | |
| Skugglist 25-8-15-15 mm  | Vit | 3050 mm | 36 st | 109,8 m | 22 kg | <u>23,80 kr/m</u> |
| U-List 25-40-13 mm U-List 25-50-13 mm  | Vit Vit | 2400 mm 2400 mm | 25 st 25 st | 60 m 60 m | 18 kg 20 kg | <u>46,00 kr/m</u> <u>50,00 kr/m</u> |
| Skuggavslutningslist 39-10-15-10-52-24 mm 39-10-15-10-82-24 mm 39-10-15-10-102-24 mm  | Vit Vit Vit | 2400 mm 2400 mm 2400 mm | 12 st 12 st 12 st | 28,8 m 28,8 m 28,8 m | 17 kg 18 kg 19 kg | <u>65,00 kr/m</u> <u>71,00 kr/m</u> <u>80,00 kr/m</u> |









VÄGGLISTER

| Produkt | Färg | Längd | Antal/kart | m/kart | Vikt | Pris |
|---|------|---------|------------|--------|-------|-------------------|
| F-list  37-27-13/15 mm | | | | | | |
| F-13 | Vit | 3000 mm | 20 st | 60 m | 22 kg | <u>33,60 kr/m</u> |
| F-15 | Vit | 4000 mm | 10 st | 30 m | 11 kg | <u>33,60 kr/m</u> |
| Ultra-flex  Flexibel L-list 24x24 | | | | | | |
| PL-FLEX | Vit | 2400 mm | 12 st | 28,8 m | | <u>94 kr/m</u> |
| PL-FLEX-IC | Vit | 2400 mm | 12 st | 28,8 m | | 145 kr/m |







UPPHÄNGNING

| Produkt / Bild | Längd | Antal/kart | Vikt | Pris |
|---|---|--|---|--|
| Justerbar Pendel Diam. 3,2 mm P-1 P-3 P-6 P-10 P-12 P-17  | 18-30 cm 30-60 cm 60-100 cm 100-125 cm 100-150 cm 100-200 cm | 100 st 100 st 100 st 100 st 100 st 100 st | 4 kg 5 kg 7 kg 10 kg 12 kg 16 kg | <u>5,30 kr/st</u> <u>6,20 kr/st</u> <u>7,35 kr/st</u> 10,70 kr/st <u>12,35 kr/st</u> <u>16,70 kr/st</u> |
| Trådstav med krok diam 3,2 | 2500 mm | 100 st | 8 kg | <u>13,60 kr/st</u> |
| Fjäder  | | 100 st | 2 kg | <u>3,20 kr/st</u> |
| Hålbånd  | 0,7x13 mm 0,7x20 mm | 25 m 25 m | 2 kg 3 kg | <u>120 kr/st</u> <u>135 kr/st</u> |
| Direktfäste  | 50 mm 80 mm 100 mm | 100 st 100 st 100 st | 3 kg 3,5 kg 4 kg | <u>4,50 kr/st</u> <u>5,40 kr/st</u> <u>6,50 kr/st</u> |

INFÄSTNING

| Produkt | Längd | Antal/kart | Pris |
|---|---|----------------------------|--|
|  Montageskruv fosfaterad svart | 4,2x16 mm | 1000 st | <u>142 kr/krt</u> |
|  Montageskruv fosfaterad svart | 4,2x22 mm | 1000 st | <u>142 kr/krt</u> |
|  Popnitskruv Vit | 3,5x9,5 mm | 1000 st | <u>162 kr/krt</u> |
|  Spikplugg | 5x25 mm | 100 st | <u>91 kr/krt</u> |
|  Drivnit , Zink och stål | 5x20 mm | 250 st | <u>252 kr/krt</u> |
|  Hålexpander | 5x45 mm | 100 st | <u>140 kr/krt</u> |
|  Ögleskruv för betong | 6x40 mm | 250 st | <u>625 kr/krt</u> |
| Bits | | | <u>145 kr/st</u> |
| | | | |
|  Montageskruv Galv | D=4,2 mm L=32 mm L=45 mm L=65 mm | 250 st 250 st 250 st | <u>96 kr/krt</u> <u>100 kr/krt</u> <u>128 kr/krt</u> |
| Lättbetongskruv | 8x90 mm | 50 st | <u>199 kr/krt</u> |
|  Takvinkel för pendel | | 100 st | <u>130 kr/krt</u> |

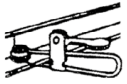
TILLBEHÖR

| Produkt | Beskrivning | Antal/kart | Pris |
|--|---|-------------------------|--|
| Hold down clips Universal  | Plattjocklek max 5x20 mm 5x40 mm | 500 st 500 st | <u>1060 kr/krt</u> <u>1360 kr/krt</u> |
| Krokodilclip  | Variabel | 100 st | <u>6,60 kr/st</u> |
| Dekorationsclips Vita  | För T-24 | 100 st | <u>19,00 kr/st</u> |
| Dekorationsclips Vita  | För T-24/T-15 | 100 st | <u>11,55 kr/st</u> |
| | | | |
| | | | |
| | | | |
| Montagehandskar  | Vita med gumminoppor | 12 st | <u>160 kr/fp</u> |
| Tredje Handen  | Galv | | <u>27 kr/st</u> |
| Jet-line  | Spännsnöre | ca. 150 m | <u>45,00 kr/st</u> |
| | | | |
| Ventilationsraster Plast Vit  Plast svart | VR 66, 600x600 mm VR 612, 600x1200 mm VR 612, 600x1200 mm | 30 st 15 st 15 st | <u>130 kr/st</u> <u>260 kr/st</u> <u>440 kr/st</u> |
| | | | |
| Armatyr LED, Varmvit | 600x600 mm | | 1500 kr/st |
| Plåtsax Wiss | Grön och röd | | <u>386 kr/st</u> |

FÖRSÄLJNINGS- & LEVERANSVILLKOR

Giltighet

Denna prislista gäller för hela förpackningar.
Leveransdagens priser gäller om ej annan har överenskommits.
Netto varuvärde per leveranstillfälle och leveransadress.

| Netto varuvärde | Expeditionsavgift |
|-----------------|-------------------|
| < 1 000 | 300 |
| 1 001 – 5 000 | 100 |
| >5 001 | 0 |

Fraktvillkor

Priserna gäller fraktfritt mottagningsort i Sverige, båt och flyg ingår ej, i poster om minst 25 000:- netto varuvärde (utgående från priserna i denna prislista) per lägerställe, leveranstillfälle och leveransadress. För leveranser mindre än 25000:- tillkommer frakt.

Leverans- och betalningsvillkor

Leveranstid meddelas i varje enskilt beställningstillfälle och avser on ej annat anges, tiden för ankomst till leveransadressen.

Emballage ingår i priser men kostnader för pall och pallkragar tillkommer.

I övrigt gäller ABM 07 "Allmänna bestämmelser för leveranser av byggmaterial", dock med följande förtydligande:

- Med köpesumma avses pris exklusive mervärdesskatt i svenska kronor.
- Reklamationsanmälan skall göras till CDC Group, det åligger köparen att informera sig vem som är reklamationsansvarig. Tidpunkten för reklamation är när reklamationsansvarig mottager reklamationen.
- Vid betalning efter förfallodagen debiteras dröjsmålsränta enligt gällande räntelag.
- Tidslossning på förfrågan samt mot avgift.

Returer

Efter överenskommelse tas oskadat material av vår lagerstandard i retur till 70% av det fakturerade varuvärdet, returfraktkostnad tillkommer. Krav på retur skall ställas inom 3 månader från att vara har mottagits. Specialprodukter återtages EJ.

Övrigt

För produkter i kulör garanteras inte exakt kulöröverensstämmelse mellan olika beställningar av samma kulör.

Översända produktprover skall betraktas som tygprover om ej annat överenskommits

Vi levererar till:
– STORA SOM SMÅ PROJEKT, INTERIÖRT SOM EXTERIÖRT



Örebro
Östra Vagngatan 5B
702 27 Örebro

Tyresö
Studiovägen 8
135 48 Tyresö

www.cdca.se

EN DEL AV AKUSTIKBYGGARNA

